



ROPE LINE 2020

HARDWARE FOR UHMWPE ROPES

UK Distributor
Proboat Ltd
Burnham Business Park
Burnham On Crouch
Essex CM0 8TE

sales@proboat.co.uk
www.proboat.co.uk
Tel: + 44 (0) 1621 785455



BLUE WAVE[®]
WIRE DESIGN SYSTEM

Information and contact

You are kindly asked to contact your local Blue Wave dealer/distributor, or Blue Wave direct, should you have questions or need further documentation.

BLUE WAVE RIGGING HARDWARE

In business since 1932, Danish based Blue Wave A/S is today among the leading manufacturers of high quality stainless steel rigging hardware. Focus has for years been on Marine, Architectural and Industrial sectors.

By constant development and investments in high tech production machinery, focus on customer needs and wishes, a well known brand name has been established.

Key factor and future aim, is continued development backed by customer commitment and driven by market demand.

Applying efficient production, good design, low weight and optimal strength to its products Blue Wave strives to become the number one chosen supplier of rigging hardware.

Manufactured to the highest quality materials and tested in their design and performance, Blue Wave components are used for marine and structural rigging around the world.

Dyneema® or Ultra-high-molecular-weight polyethylene (UHMWPE, UHMW) ropes have the advantage of a ultra high strength versus weight while being highly flexible.

As an alternative to e.g. stainless steel wires, the synthetic fiber ropes used in various applications feature a significant advantage compared to traditional materials and have opened a new field of possibilities and features in rigging.

The Blue Wave RopeLine

Being a world leading manufacturer in the field of end fittings for wire and rod rigging, Blue Wave has now also developed a range of end fittings for fiber ropes like Dyneema®

Materials used are Stainless Steel AISI316 and marine grade aluminium.

Standard hardware solutions amongst others include:

- Eyes
- Forks
- Ball Ends
- Threaded Studs
- Turnbuckles
- T-Ends
- Swage Fitting Connections
- Heavy Duty Thimbles
- Reinforced Thimbles



All fittings are engineered and tested to break loads stated in the technical schemes and guarantees safe and reliable performance.

Copyright Gleistein Ropes

Correct attachment

When terminating high modulus fiber like Dyneema® rope a knot for example can reduce the ropes strength by up to 60% and will seat and slip under load.

All Blue Wave end fittings are made for and tested with spliced rope attachment.

For correct attachment/splicing contact your local rigger.

Safe working loads

Blue Wave recommends that safe work loads should not to exceed one fifth (1/5) of the break loads listed.

Dyneema® is a registered trademark of DSM



BLUE WAVE®

ROPE END FITTING

- New innovative product
- More opportunities to benefit from UHMWPE and UHMW ropes
- Unique and slim design
- Easy and viable to use and assemble
- AISI316L stainless steel, and black anodized aluminium
- Easy to fit to existing rigging screws and deck fittings
- Backed by a full range of high quality rigging hardware



Community Design Registration 14/6 2017
design reg. -004048098-0001



"KEEP IT SIMPLE"



Slide the housing over the rope



Splice around the bone - following your rope suppliers general splice guidelines



Pull spliced bone back in housing



Screw the parts together - threads can be locked with Loctite

ROPE FITTINGS

ROPE EYE TERMINAL

Polished Stainless Steel - AISI 316

ART. NO.	DEYNEEMA	A	D1	D2	D3	KW	L1	L2	L3	BL/KG	KG/100
RP820804	Ø4	5	16	8,5	8	11	45	12	27	1900	3,8
RP821005	Ø5	6	21	10,5	12	16	58,5	14,5	35	3200	8,5
RP821206	Ø6	9	25	13	14	19	71	17,5	42	5500	15,5
RP821408	Ø8	10	39	14,5	20	29	103,5	29,5	62	9400	47,2
RP821610	Ø10	13	45	16,2	24	33	120	34	70	15000	75,5
RP821912	Ø12	15	54	19,5	30	40	136,5	38	80	18000	117,1
RP822214	Ø14	18	65	23	34	47	163	42	94	26000	207,5
RP822516	Ø16	20	75	26	40	55	192	58	113	32000	302,2

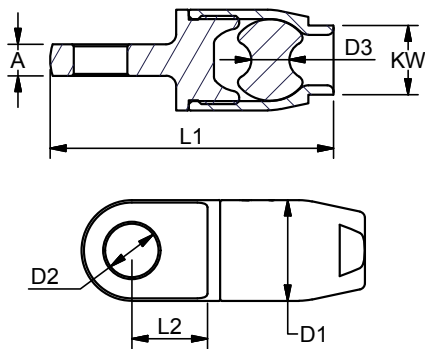

Blue Wave's rope fittings are made from high quality stainless steel and marine grade aluminum. Has an eye-catching design, solid construction and smooth look. Opens opportunities for use with ropes from Ø4-16mm.



Community Design Registration 14/6 2017
design reg. -004048098-0004

ROPE FORK TERMINAL

Polished Stainless Steel - AISI 316

ART. NO.	ROPE SIZE	PIN	A	B	C	D1	D2	KW	L1	L2	BL/KG	KG/100
RP840804	4	8	6,5	16	9	16	8	11	53	34	1900	6,4
RP841005	5	9,5	9	21	11	21	12	16	67	43	3200	12,3
RP841206	6	12,7	11	26	13,5	25	14	19	83	53	5500	21,9
RP841608	8	16	14	32	17	39	20	29	110	68	8000	59,6
RP841910	10	19	18	35	21	45	24	33	128	77	11000	96,1

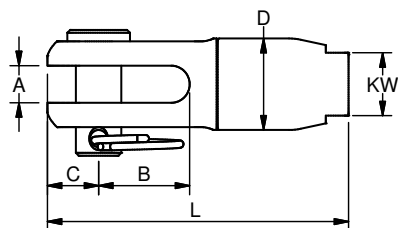

Community Design Registration 14/6 2017
design reg. -004048098-0004

ROPE FITTINGS

ROPE BALL TERMINAL

Polished Stainless Steel - AISI 316

ART.NO.	Size	D1	D2	D3	D4	G	L1	L2	L3	BL/KG	KG/100
RP621404	4	7,5	16	14,6	8	5/16"	60	19	42	1900	5,2
RP621604	4	7,5	16	16	8	5/16"	60	19	42	1900	5,4
RP621904	4	9	16	19	8	3/8"	60	18	40	1900	6,5
RP621405	5	9	21	14,6	12	3/8"	66	18	45	3200	9,4
RP621905	5	9	21	19	12	3/8"	68	18	45	3200	10,2
RP622005	5	12,6	21	20	12	1/2"	70	19	48	3200	11,8
RP622105	5	12,6	21	21,3	12	1/2"	70	19	48	3200	12,1
RP622006	6	12,6	25	20	14	1/2"	76	20	51	5500	17,1
RP622106	6	12,6	25	21,3	14	1/2"	76	19	51	5500	17,4
RP622606	6	14,2	25	26,5	14	9/16"	88	23	59	5500	21,9
RP622608	8	16	39	26,3	20	5/8"	119	31	82	8250	57
RP622708	8	17,8	39	27,5	20	3/4"	120	31	83	9400	58,9

10mm - 12mm only on request.

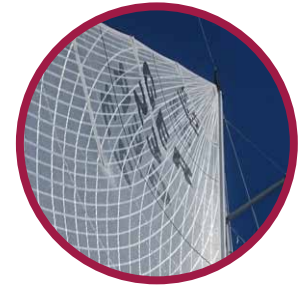
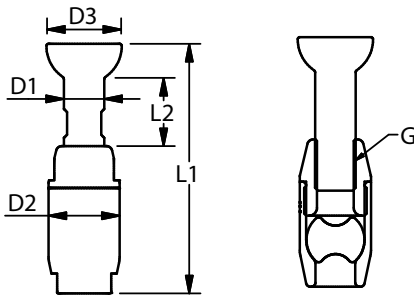

Community Design Registration 14/6 2017
design reg. -004048098-0002

ROPE T-TERMINAL

Polished Stainless Steel - AISI 316

ART.NO.	Size	D1	D2	T	L1	L2	KW	BL/KG	KG/100
RP867504	4	16	8	7,5	66	49	11	1500	5,3
RP860904	4	16	8	9	72	53	11	1900	6,6
RP860905	5	21	12	9	82	60	16	2800	10,1
RP861205	5	21	12	12,6	97	71	16	3200	15,8
RP861206	6	25	14	12,6	109	91	19	5000	21,9
RP861406	6	25	14	14,2	115	85	19	5500	25,3
RP861608	8	39	20	16	151	110	29	8000	61,2
RP861808	8	39	20	17,8	154	112	29	9400	67,3

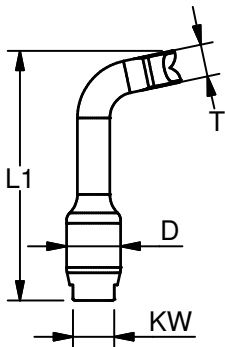

Community Design Registration 14/6 2017
design reg. -004048098-0005

ROPE FITTINGS

ROPE THREAD TERMINAL

Polished Stainless Steel - AISI 316

ART.NO.	Size	G	D1	D2	L1	L2	L3	BL/KG	KG/100
RP800406A	4	1/4"	16	8	87	48	70	1300	5,1
RP800408A	4	5/16"	16	8	95	57	48	1900	6,2
RP800508A	5	5/16"	21	12	106	57	86	2200	10,7
RP800510A	5	3/8"	21	12	111	63	90	3200	12,1
RP800610A	6	3/8"	25	14	122	63	98	2850	18,2
RP800611A	6	7/16"	25	14	126	68	102	3850	20,1
RP800612A	6	1/2"	25	14	138	80	113	5150	22,9
RP800812A	8	1/2"	39	20	163	80	130	5150	55,9
RP800816A	8	5/8"	39	20	182	100	149	8250	64,5
RP801020A	10	3/4"	45	24	216	120	178	12050	102,8

Larger sizes on request.

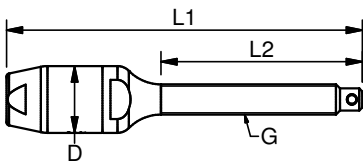

Community Design Registration 14/6 2017
design reg. -004048098-0003

ROPE FORK

Black Anodized Aluminium - With AISI 316L PIN

ART. NO.	ROPE SIZE	PIN	A	B	C	D1	D2	D3	KW	L1	L2	BL/KG	KG/100
RA840804	4	8	9	17,5	10,5	20	23	8	14	57	36	2800	4,3
RA841105	5	11,1	11	23	14	24	29	12	17	79	50	4300	9,6
RA841306	6	12,7	14	27	16	27	35	14	21	90	57	6100	13,6

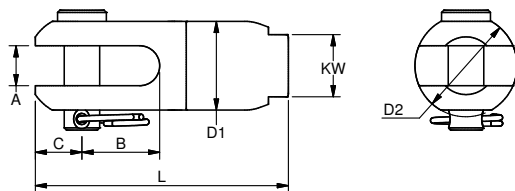

Community Design Registration 14/6 2017
design reg. -004048098-0001

ROPE EYE

Black Anodized Aluminium

ART. NO.	SIZE	A	D1	D2	D3	L1	L2	L3	BL/KG	KG/100
RA820804	4	8	19	8,5	8	48	12	12	2800	2,2
RA821105	5	10	24	11,5	12	66	16	16	4300	4,8
RA821206	6	13	27	13,0	14	75	18	18	6100	7,5
RA821608	8	16	40	16,5	20	106	29	29	8900	19,8
RA821910	10	19	45	19,3	24	122	34	34	12200	29
RA822212	12	21	54	22,5	30	141	38	38	16900	45,6
RA822514	14	24	65	26	34	168	42	42	24600	80,6
RA822816	16	26	76	28,5	40	201	57	57	33500	128,3

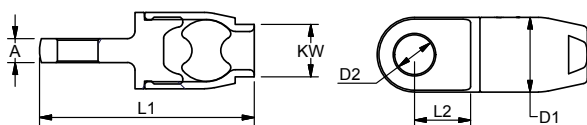

Community Design Registration 14/6 2017
design reg. -004048098-0004

ROPE RIGGING SCREWS AND T-ENDS

ROPE RIGGING SCREW

Polished Stainless Steel - AISI 316

ART. NO.	THREAD G	ROPE	PIN	A	B	D	L1	L2	R	T	BL/KG	KG/100	PACK
331906AF	1/4"	3mm	6,35	8	17	7,5	215	155	2,5	5	1300	11,2	10
331908AF	5/16"	4mm	8	10	20	9,5	267	191	4	8	2200	20,8	10
331910AF	3/8"	5mm	9,5	12	26	13,5	307	225	5	12	3400	35,3	10
331911AF	7/16"	6mm	11,1	15	28	13,5	342	254	5	12	4600	53	10
331912AF	1/2"	7mm	12,7	18	35	17,5	380	276	7	16	6100	78,6	BULK
331916AF	5/8"	8mm	16	20	41	17,5	478	342	7	16	9900	133,5	BULK

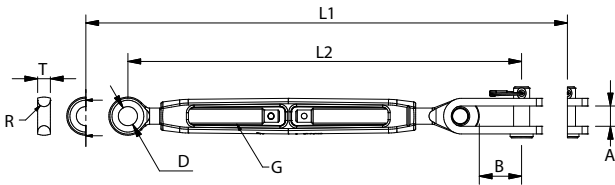

The Blue Wave Chromed Bronze Body riggingscrew is the best choice for exclusive and durable rigging. The sleek, open Bronze body prevents the threads from seizing up, they are delivered with laser engraved thread size, Blue Wave logo, and side marking for left hand thread.

ROPE EYE

Polished Stainless Steel - AISI 316

ART. NO.	ROPE SIZE	B1	B2	D	L1	L2	T	BL/KG	KG/100	PACK
616506	3	27	15	6,35	81,5	26	6,3	800	3,8	BULK
616507	4	27	15	7,5	85	26	7,5	1800	4,1	BULK
616509	5	38	22	9	99,5	34	9	2800	8,7	BULK
616512	6	38	22	12,58	109	34	12,58	4100	10,2	BULK

NOTE: See Blue Wave Marine range for back plates.

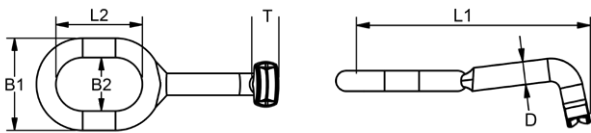

SMALL T-ROPE EYE

Polished Stainless Steel - AISI 316

ART. NO.	ROPE	A1	A2	D1	D2	D3	R	FITS IN ART NO.	KG/100	PACK
616506F	Ø3	5	6,35	7,5	15	6,35	2,5	616103	1,4	10
616507F	Ø4	6,5	7,5	9,6	18	7,5	3,25	616105	3,1	10
616508F	Ø4	8	9	9,5	18,5	9	4	616105	3,9	10
616512F	Ø5-Ø6	12	14	13,5	29	14	5	616107	12,1	10
616516F	Ø7-Ø8	16	18	17,5	35,5	18	7	616110	27	10

NOTE: See Blue Wave Marine range for back plates.

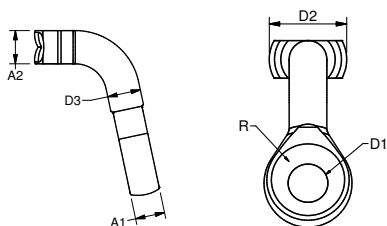

WELDED ROPE FITTINGS

T-TERMINAL W. EYE / TRAPEZE T

Polished Stainless Steel - AISI 316

ART. NO.	WIRE	B	D1	D2	D3	L1	L2	L3	T	KG/100	PACK
610025LRT	2,5 - 3/32"	15	5,5	8	18	83	32	31	6,3	2,7	20
610003LRT	3 - 1/8"	15	6,35	8	18	83	38	31	6,3	3	20
610025RT	2,5 - 3/32"	15	5,5	8	18	83	32	31	6,3	2,4	20
610003RT	3 - 1/8"	15	6,35	8	18	83	38	31	6,3	2,7	20
610025LT	2,5 - 3/32"	15	5,5	8	18	83	32	31	6,3	2,4	20
610003LT	3 - 1/8"	15	6,35	8	18	83	38	31	6,3	2,7	20

NOTE: See Blue Wave Marine range for back plates.

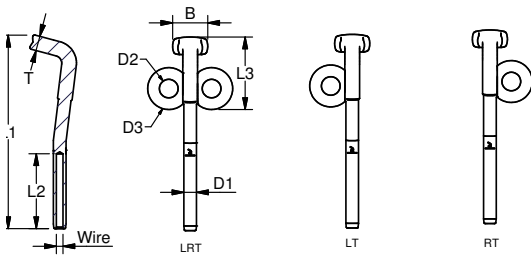

ROPE TERMINAL

Polished Stainless Steel - AISI 316

ART. NO.	WIRE SIZE	L1	L2	L3	L4	L5	D1	D2	D3	BL/KG	KG/100	PACK
651025	2,5	83	26	27,2	32	15	5,5	2,8	6	800	2,6	BULK
651003	3	90	26	27,2	38	15	6,35	3,5	6	1300	2,9	BULK
651004	4	96	26	27,2	45	15	7,5	4,4	6	2600	3,4	BULK

Note: All break loads are determined by ring & terminal

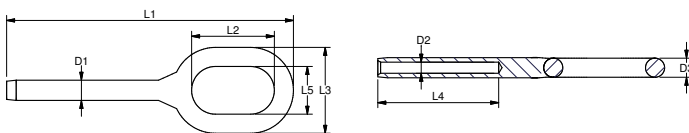

ROPE THREAD EYE

Polished Stainless Steel - AISI 316

ART. NO. RIGHT	THREAD G	D1	D2	L1	L2	T	BL/KG	KG/100	PACK
021906AF	1/4"	7,5	16	61	47	5	1300	1,8	10
021908AF	5/16"	9,5	24	78	57	8	2200	4,6	10
021910AF	3/8"	13,5	32	87	63	10	3400	8,5	10
012911AF	7/16"	13,5	32	93	68	10	4600	10,4	10
021912AF	1/2"	17,5	41	110	80	14	6100	19,2	BULK
021916AF	5/8"	17,5	41	130	100	14	9900	27,4	BULK

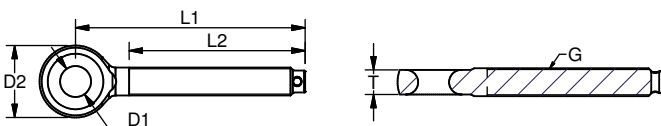

GUARD RAIL FITTINGS



RIGGING SCREW W. INTEGRATED ROPE TERMINAL

Polished Stainless Steel - AISI 316 - Chromed Bronze Body

ART. NO.	THREAD G	ROPE	PIN	A	B	L1	L2	BL/KG	KG/100
RP130408A	5/16"	4 mm	8	7	16	261	187	1700	76,1

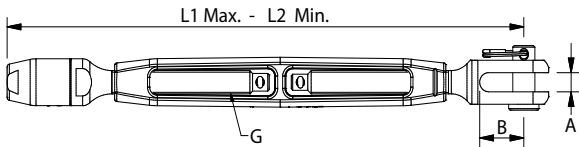

Threaded toggle also available



Community Design Registration 14/6 2017
design reg. -004048098-0003

ROPE FORK TERMINAL

Polished Stainless Steel - AISI 316

ART. NO.	ROPE SIZE	PIN	A	B	C	D1	D2	KW	L1	L2	BL/KG	KG/100
RP840804	4	8	6,5	16	9	16	8	11	53	34	1900	6,4

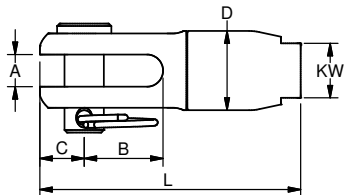

Community Design Registration 14/6 2017
design reg. -004048098-0001

ROPE RELIEF

Nylon

ART. NO.	D1	D2	D3	L1	L2	FOR HOLE SIZE	KG/100	PACK
A6504	4,2	13	9,2	11,2	8	9	0,1	100
A6505	5,7	14	10,2	13,1	10	10	0,13	100
A6506	6,4	14	10,2	13,1	10	10	0,12	100
A6508	8,4	15,6	13,2	13,1	10	13	0,14	100

Black split bushing for push or glue in.
Reduces wear on the rope.

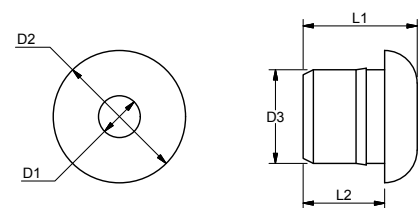

GATE-HOOK

Polished Stainless Steel - AISI 316

ART. NO.	THREAD	D1	D2	L1	L2	BL/KG	KG/100	PACK
GH06	M6	10	17	81	10	500	9,6	BULK
GH06A	1/4"	10	17	81	10	500	9,5	BULK
GH08	M8	13	19	103	11,5	1200	14,5	BULK
GH08A	5/16"	13	19	103	11,5	1200	14,4	BULK

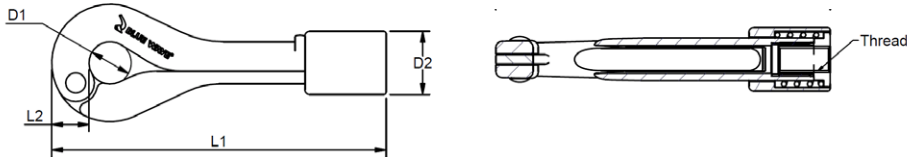

This top of the line Gate-Hook, is one hand operated and based on the "over the center" principal where the load is carried on the body.



Community Design Registration 8/8 2019
design reg. -006691655-0001

ROPE THREAD, SMALL - FOR GUARD RAIL AND GATEHOOK

Polished Stainless Steel - AISI 316

ART. NO.	SIZE	G	D	L1	L2	BL/KG	KG/100
RP800406K	4	M6	14	56	25	1100	3,4
RP800406S	4	M6	14	79	48	1100	3,9
RP800508K	5	M8	17	64	30	1700	5,4
RP800508S	5	M8	17	91	57	1700	6,5
RP800608K	6	M8	18	67	30	2200	6,3
RP800608S	6	M8	18	94	57	2200	7,4
* RP801208K	12	M8	20	85	30	2500	10,7
* RP801208XS	12	M8	20	112	57	2500	11,9

* For double braided polyester ropes, cover splice only.

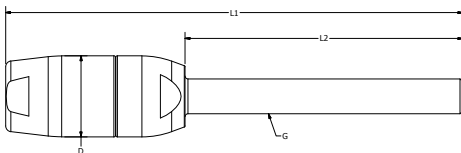

Rope Terminal for Gatehook with Ø 12 mm double braid – only cover spliced!



Community Design Registration 14/6 2017
design reg. -004048098-0003

ROPE EYE FOR GATE-HOOK

Polished Stainless Steel - AISI 316

ART. NO. LEFT	THREAD G	D1	D2	L1	L2	T	BL/KG	KG/100	PACK
031906AF	1/4"	7,5	16	55	41	5	1300	1,7	10
031908AF	5/16"	9,5	24	72	51	8	2200	4,4	10

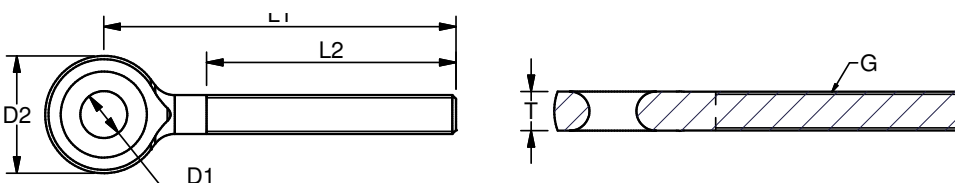

GUARD RAIL FITTINGS & WHEEL THIMBLE

GUARD RAIL FITTINGS - ROPE TERMINAL

Polished Stainless Steel - AISI 316

ART. NO.	WIRE	THREAD G	L1	L2	L3	D1	D3	BL/KG	KG/100	PACK	
650003	3	1/8"	5/16"	60	38	10	6,35	26	1300	3,9	20
650004	4	5/32"	5/16"	68	45	11	7,5	26	1700	4,2	20
650005	5	3/16"	5/16"	76	51	11	9	26	2200	4,9	20

The user is responsible for choosing the proper cable diameter and for correct assembly.

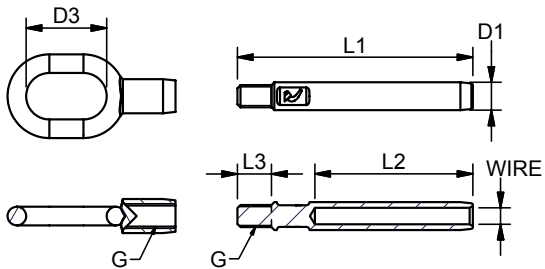

WHEEL THIMBLE

Polished Stainless Steel - AISI 316

ART. NO.	ROPE SIZE	D1	D2	D3	Ø	L	KG/100
RP1105	3-5	5	5,3	15,5	7,8	7,3	0,5
RP1106	4-6	6	6,5	17,5	9	9,2	0,8
RP1108	5-7	7	8,3	21,5	11,2	10,8	1,3
RP1110	6-8	8	10,3	25,5	13,2	12,8	2,2

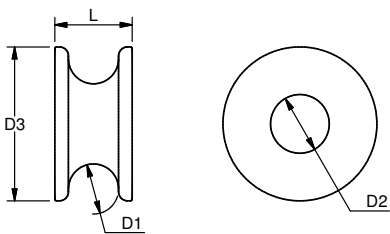

LOW FRICTION RING

Black hard anodized 6061 aluminium

ART. NO.	ROPE SIZE	Ø	D1	D2	D3	L	KG/100
RA1105	4-5	11	5	7	18	9	0,1
RA1107	6-7	15	7	10	25	12	0,2
RA1110	8-10	19	10	14	35	15	0,6
RA1114	12-14	28	14	20	50	22	1,4

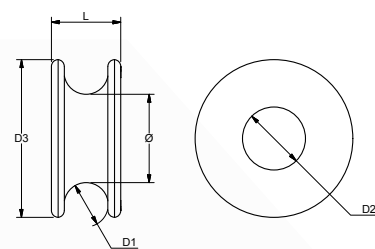

THIMBLES

THIMBLES

Polished Stainless Steel - AISI 316

ART. NO.	A	A1	B	L	S	KG/100	PACK
110002	3	5,25	9	16	1	0,2	100,0
110003	4	6,25	10	17	1	0,3	100,0
110004	5	7,5	11	19	1,35	0,5	100,0
110005	6	8,5	13	21	1,2	0,7	100,0
110006	7	9,7	15	27	1,5	1,1	100,0
110007	8	11	19	33	1,5	1,4	100,0
110008	9	13,5	22	38	2	2,6	50,0
110009	10	13,75	24	43	2	3,1	50,0
110010	11	15,3	27	46	2,7	4,9	BULK
110012	14	18,3	29	52	2,7	6,6	BULK
110014	16	21	33	57	3	9	BULK
110016	18	23	40	67	3	11,3	BULK
110018	20	26,5	45	75	4	19	BULK
110020	22	30,5	52	84	4	31,2	BULK
110022	24	32	56	93	5	45,5	BULK
110026	28	37,5	65	112	6	67	BULK
110028	30	40	80	135	5,5	82	BULK
110032	34	43	92	160	6,25	110	BULK
110034	36	46,5	105	160	6	117	BULK
110036	38	49	115	176	6	142	BULK
110038	40	53,5	120	180	8	206	BULK
110040	42	55	120	192	8	220	BULK
110042	45	56,5	150	240	8	304	BULK

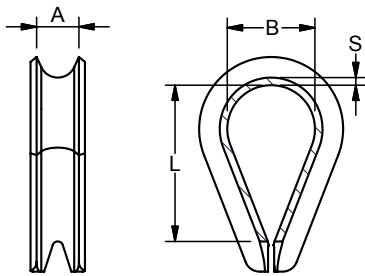

The thimbles from Blue Wave are known worldwide for supreme quality and are often the first choice for the harsh environment of the marine sector.

Copyright Gleistein Ropes



THIMBLES WELDED

Polished Stainless Steel - AISI 316

ART. NO.	Ø	A	A1	B	L	S	KG/100	PACK
119908	6	9	13,5	22	22	2	2,9	25
119909	6	10	13,75	24	24	2	3,2	25
119910	8	11	15,3	27	27	3	5,9	25
119912	8	14	18,3	29	29	3	6,3	25
119914	10	16	21	32	32	3	12,3	10
119916	10	18	23	40	40	3	13,6	10
119918	12	20	26,5	45	45	4	24	10
119920	12	22	30,5	50	50	4	34,8	10
119922	16	24	32	56	56	5	51,8	BULK
119926	16	28	37,5	60	60	6	85,6	BULK

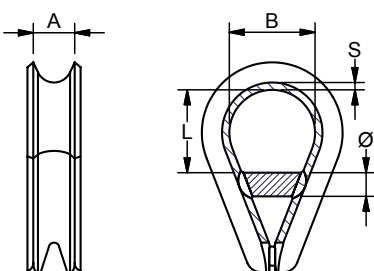

The reinforced thimble is based on the standard thimble but extra force is attained by the addition of a welded bar, as well as the ends of the thimbles being welded together.

Copyright Gleistein Ropes





ROPEBONE AND TOOLS FOR SAIL THIMBLE

ROPEBONE

Polished Stainless Steel - AISI 316

ART. NO.	ROPE SIZE	L	D1	Ø
RP0608	3 mm	36	8	3
RP0610	3 - 5 mm	45	10	4
RP0612	5 - 7 mm	52	13	4

ROPEBONE

Black Anodized Aluminium

ART. NO.	ROPE SIZE	L	D1	Ø
RA0608	3 mm	36	8	3
RA0610	3 - 5 mm	45	10	4
RA0612	5 - 7 mm	52	13	4



Low weight

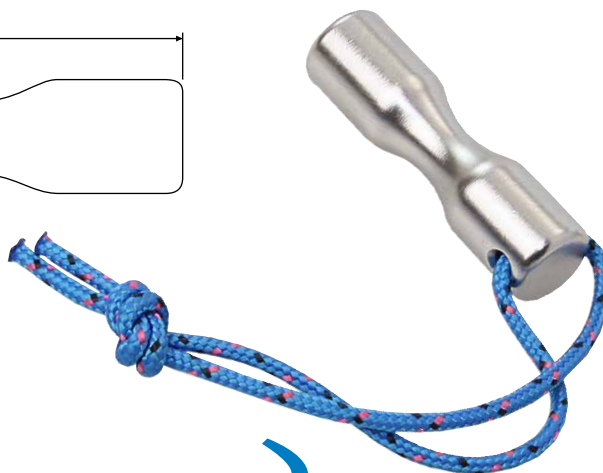
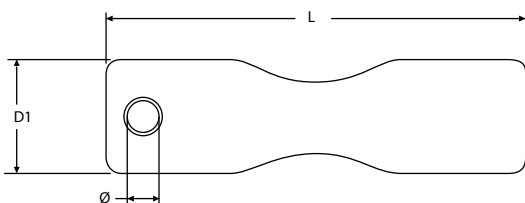

SAIL THIMBLES AND TOOL

SAIL THIMBLE

ART. NO.	D1	D2	L1	PACK	KG/100
111415	14	16	16	10	0,5
111419	14	16	19	10	0,7
112016	20	22	16	10	0,8
112019	20	22	19	10	1
112022	20	22	22	10	1,1
112026	20	22	26,5	10	1,4

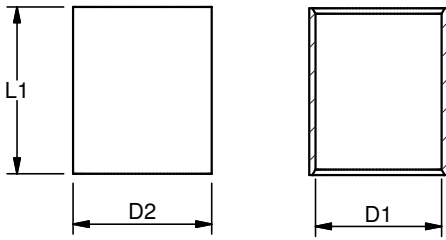

PRESSING TOOL FOR SAIL THIMBLE

ART. NO.	INNER Ø	D1	D2	L	KG
RIGTOOL14	14	35	10	35	0,7
RIGTOOL20	20	42	14	40	0,7

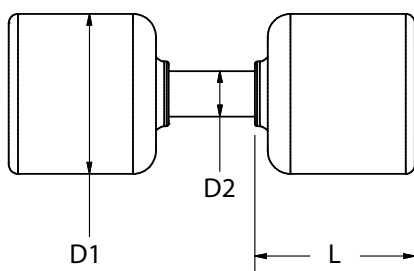

www.proboat.co.uk

Blue Wave reserves the right without notification, to change specifications and descriptions contained in the Rope Line Catalogue. 2020 - 1. edt.